

SECTION A—A

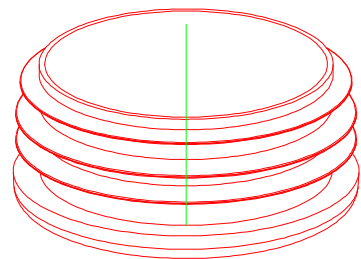
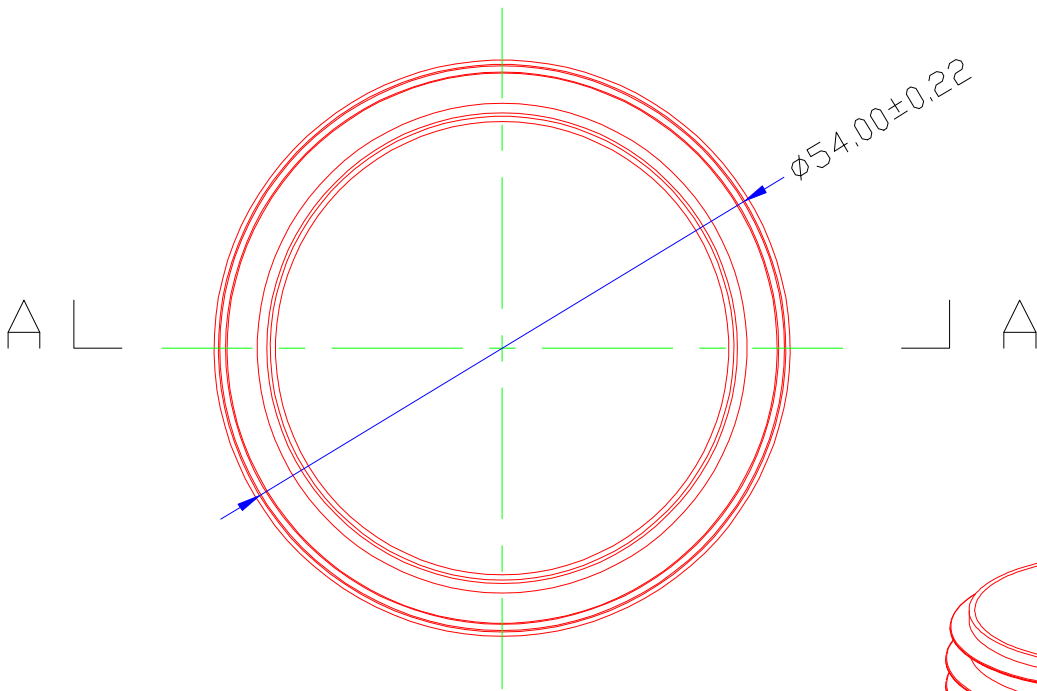

Checked by (审核)	drawer (绘图)	Designed by (设计)	Material (材料)	Weight (重量)	Scde 1:1 (比例)	Project View (第一角投影)	Date (日期)
		汤尹权	PE	11.9±0.35g	1:1	(mm)	10/04/2017
 SINO HOLDINGS www.sinogroups.com			Name(名称) :				
			SINO577022-2-14				
TEL:86-576-84023777 FAX:86-576-84018996 Eml:mould@china.com Url:www.cnmould.com							